

HabiPLAST[®] Profiles C-07



Your Source For Habasit
Belting And Chain

www.StilesEnterprises.com • 1-800-325-4232

Description

Machined PE profile with a very low coefficient of friction and high resistance to chemical agents. Used as a sliding support for plastic modular belts and chains, or as a guiding aid for various purposes.

This is used in a wide range of industries such as bottling, packaging, materials handling, and food processing.

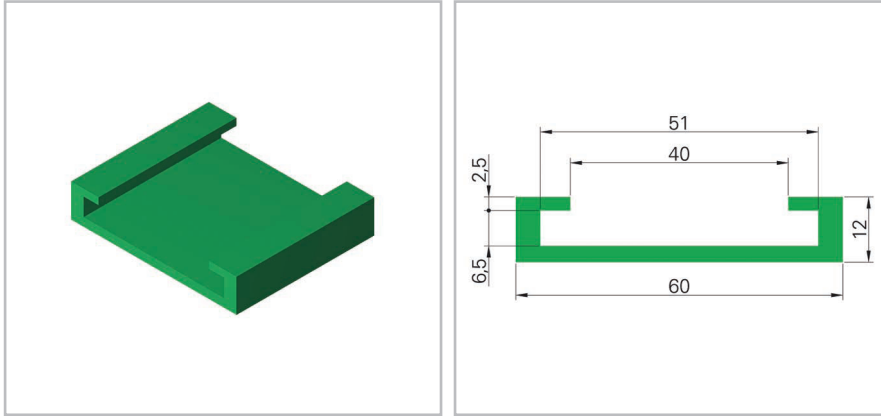

Product data

Habasit code	Material	Color	Packaging unit
C-07	UHR	green	Bar
C-07	UHR	black	Bar
C-07	H/SA	white	Bar

Standard material: Habiplast[®] UHR green and black, and H/SA white. Other materials are available on request.

Standard length: 3.0 m - other lengths are available on request

For detailed material properties and other colors please contact your Habasit representative.

Note: All data are approximate values under standard climatic conditions: 23 °C / 73 °F, 50% relative humidity (according to DIN 50005 / ISO 554).

Product liability, application considerations

If the proper selection and application of Habasit products are not recommended by an authorized Habasit sales specialist, the selection and application of Habasit products, including the related area of product safety, are the responsibility of the customer.

All indications / information are recommendations and believed to be reliable, but no representations, guarantees, or warranties of any kind are made as to their accuracy or suitability for particular applications. The data provided herein are based on laboratory work with small-scale test equipment, running at standard conditions, and do not necessarily match product performance in industrial use. New knowledge and experiences can lead to modifications and changes within a short time without prior notice.

BECAUSE CONDITIONS OF USE ARE OUTSIDE OF HABASIT'S AND ITS AFFILIATED COMPANIES CONTROL, WE CANNOT ASSUME ANY LIABILITY CONCERNING THE SUITABILITY AND PROCESS ABILITY OF THE PRODUCTS MENTIONED HEREIN. THIS ALSO APPLIES TO PROCESS RESULTS / OUTPUT / MANUFACTURING GOODS AS WELL AS TO POSSIBLE DEFECTS, DAMAGES, CONSEQUENTIAL DAMAGES, AND FURTHER-REACHING CONSEQUENCES.